

Case Study

A Case Study of Rainfall Runoff Modelling for Shipra River Basin

Ayushi Trivedi^{1*}, S. K. Pyasi¹, R.V. Galkate² and Vinay Kumar Gautam³

¹Department of Soil and Water Engineering, J.N.K.V.V, Jabalpur, India

²National Institute of Hydrology, WALMI Campus, Bhopal, India

³Department of Technology and Engineering, MPUAT, Udaipur, Rajasthan, India

**Corresponding author*

ABSTRACT

A model is a small scale representation of a real world system, and consists of a set of simultaneous sets of equations or a logical sequence of operations contained within a computer program. Models have parameters which are numerical representation of a property or characteristics that are constant under specified conditions and variable in other sets of conditions. Runoff is one of the most prominent hydrological variables used in most of the water resources applications. Sound information on quantity and rate of runoff from land surface into streams and rivers is vital for integrated water resource management. This set of information is needed in dealing with watershed development and management problems. A rainfall- runoff model is a mathematical model describing the rainfall - runoff relations of a catchment area, drainage basin or watershed. Keeping this in view, a comprehensive study on estimation of rainfall and runoff estimation generated from rainfall was performed in Shipra river basin and its four subbasins (Ujjain, Indore, Dewas, Sanwer) using RRL AWBM Model and its suitability was determined based on criterion that is Coefficient of Determination, Coefficient of correlation, Efficiency Index and Root Mean Square of Error. The Nash Sutcliffe Efficiency for the calibration is found to be 82.30 % and for the validation period was found to be 64.57 %.

Keywords

RRLAWBM
Model, Coefficient
of determination,
Coefficient of
correlation,
Efficiency index,
Root mean square
error, Nash
Sutcliffe efficiency

Introduction

Extreme level water scarcity occurs in most of the countries, basically in India, and water use in agriculture sector is on the verge of extinct or very much limited and conversely the demand is on large hike. For the planning of any of the realistic policy for the suitability according to crop requires a comprehensive understanding of the climate change, prominently rainfall (its spatial and temporal availability and the variations), evaporative demand (solar radiation, wind speed and

temperature) and currently available resources of water. A full proof understanding of all above mentioned climatic parameters is very much important to determine the level of risk in arable agricultural areas. Apart from climate change currently human activities (such as land use/land cover change, dam construction and operation of large reservoirs, and soil and water conservations is playing a crucial and important role in the changes of discharge. One of the ways to assess the impact of climate change on resources of water is to

apply climate change scenarios in fusion with rainfall-runoff models to estimate the amount of runoff and stream flow. Consecutively modelling is undertaken to simulate water storage quantity, quality, allocation and use of resources. Numbers of approaches for the estimation of runoff are available from lumped to physically based distributed models. The paper describes the use of RRL AWBM (Rainfall Runoff Library Australian Water Balance Model), to investigate its performance, efficiency and suitability in Shipra river basin in Madhya Pradesh, India.

The key point objective of this study was to develop rainfall runoff model for runoff simulation using RRL toolkit AWBM model for Shipra river basin and to investigate its Performance, Efficiency and Suitability in the basin.

Study area

The one of the most prominent river in Madhya Pradesh state of Central India is Shipra. The origination of the river is at Kakri Bardi hill of Vindhya Range, 20 km South-East of Indore city near a small village Ujjani 22° 31' North and 76° East. The river arises in the North of Dhar district, and flows consecutively north across the Malwa Plateau and joins the Chambal River at the MP-Rajasthan boundary in the Mandsoor district.

It is one of the most sacred rivers in Hinduism religion. The holy city Ujjain is situated on its east bank of the river. After every 12 years, the Sinhashta fair (Kumbh Mela) is organised on the city's elaborate riverside ghats to perform yearly celebrations of the river goddess Kshipra. There are numbers of Hindu shrines along the banks of the river Shipra. Shipra is a one of the perennial river. Previously there used to be ample amount of water in the river. Now the river loses its perennial behaviour after a

couple of months after the monsoon. Upstream of its confluence with the Chambal, the Shipra has a catchment area of 5600 km². It is therefore considered as sacred as the Ganga River by the Hindus. The Shipra River is located at an average altitude of 553 metres above MSL. The region is known for its fertile soil, gentle slopes and moderate rainfall. The region has flat topography with very gentle slopes varying from 1 in 1000 to 1 in 3000. The river flows in a general north-westerly direction and has a very sinuous course. The total course of river Shipra is about 190km which flows through Indore, Dewas and the Gwalior districts of the state, it finally meets the Chambal near the Kalu-Kher village (23° 53' N. and 75° 31"). The main tributaries of the Shipra River include the Khan River near Ujjain and the Ghambir River near Mahidpur. The main course of the Shipra lies over the grassy plains of Malwa between low banks and from Mahidpur and it is characterised by high rocky banks.

Materials and Methods

The present study has been carried out at National Institute of Hydrology, Regional Centre, Bhopal as a part of their research program. Thus data collected by NIH from various State and Central agencies was used in the study for analysis. The daily rainfall data collected from IMD, Pune and State Water Data Centre, Water Resources Department, Govt. of Madhya Pradesh, Bhopal was used in the study. The meteorological data of Indore observatory collected from IMD, Pune like relative humidity, wind speed, sunshine hours, mean and maximum temperature, etc. was used in the study.

The basic data required for the set up of AWBM model is listed below:

Area of catchment in km²

Rainfall data daily time series in.tts format, mm/day

Actual Evapotranspiration data daily time series in.tts format, mm/day

Observed data daily time series in.tts format, mm/day or m³/s.

There are total number of nine parameters involved in the RRL AWBM model

A1 Partial area of the smallest store

A2 Partial area of the middle store

A3 Partial area of the largest store

C1 Capacity of smallest store

C2 Capacity of middle store

C3 Capacity of largest store

BFI Base flow index

K_{base} Base flow recession constant

K_{surf} Surface flow recession constant

For AWBM model the basic input time series data are rainfall data, runoff data and meteorological data that are used for simulation, calibration, validation. The present study involves the collection of rainfall data at Ujjain, Indore, Dewas and Sanwer rain gauge stations for Shipra basin. CROPWAT software is used to calculate evapotranspiration.

After putting all the information related to model and the model was run for limited time period with proper time step and saved the output of the model for analysis. The sensitivity analysis is done so as to determine that how sensitive the model is to certain

parameters. It is useful to identify with how the model functions and also what consideration of parameters in comparison to other parameter.

It is used to conclude that the model is extensively affected by a particular parameter then the centre of focus of calibration should be on that parameter. The uncertainty of the model will also be closely related to the uncertainty in estimating the most sensitive parameters. The AWBM provides a feature to examine the sensitivity of all the model parameters. In our study, the sensitivity analysis was performed for all the parameters and the sensitivity graphs for each parameter were obtained.

Calibration

Calibration involves a series of actions to standardize forecasted or simulated values, using the deviation of the values from observed values for any particular area. It is thus helpful in deriving the correction factors which should be applied to generate the predicted values.

These simulated values should be consistent with the observed values. When the AWBM model was set up, model was calibrated from 1st Jan 1990 to 31st Dec 2000. The model was allowed to run in auto-calibration mode. To assist the calibration of models optimisers that are provided includes:

Genetic algorithm

Shuffled Complex Evolution

Multi start pattern search

Pattern search

AWBM Auto calibration (only for AWBM model)

Warm up

Initially the model is ready for start up, requirement of some estimate of soil moisture in each of the store is needed. This is done by the model warm up in which the precipitation conditions prior the start of the model is known. It can also be done by selection of warmup period such that the soil store should be at a known point. In wet conditions, the warmup period will be wet and thus all the stores may be fully saturated. When the warmup period will be dry i.e. in dry conditions, then stores may be empty.

AWBM provides the facility of setting the warm up periods automatically for both the calibration and the validation. The AWBM model tests the prior conditions and determines where the answer is converge. However, if there is no convergence, warning blinks and the period of warm up can be adjusted manually.

Validation

The calibrated model performance is tested over the whole period where historical records were not been used for calibration, is termed as validation. The validation period was done for the year 2001 to 2010. During validation, the set parameters obtained by calibration were used and the model was run without auto-calibration mode to simulate runoff. The results were examined and comparison of simulated and observed runoff was made to verify the potential of the model.

Accuracy criteria

Accuracy is the characteristics of a measurement that indicates the degree to which the results of measurement, approach the true value of the measured quantity. The smaller the deviation of the result of measurement from the true value of quantity that is the smaller the error the higher the

measurement accuracy. It can be calculated on the basis Coefficient of Determination, Coefficient of correlation, Efficiency Index and Root Mean Square of Error.

Models are analysed on the basis of following accuracy criteria:

Coefficient of Determination

Coefficient of correlation

Efficiency Index

Root Mean Square of Error

Coefficient of determination (R^2)

Coefficient of determination is a method to evaluate the reliability of the model between the simulated and observed runoff data given in equation 2

$$R^2 = \frac{\sum_{i=1}^n \{(Q_{obs_i} - \overline{Q_{obs}})(Q_{sim_i} - \overline{Q_{sim}})\}}{\sqrt{\sum_{i=1}^n (Q_{obs_i} - \overline{Q_{obs}})^2 \sum_{i=1}^n (Q_{sim_i} - \overline{Q_{sim}})^2}} \dots (2)$$

Where,

Q_{obs_i} = Observed discharge

$\overline{Q_{obs}}$ = Average observed discharge

Q_{sim_i} = Simulated discharge

$\overline{Q_{sim}}$ = Average simulated discharge

The range of this evaluation parameter lies between 0 to 1 which describes how much of the observed dispersion is explained by the prediction. A value of zero means no correlation at all while a value of 1 means that the distribution of the prediction is equal to that of the observation. A model which steadily over predicts or under predicts all the time will give outcome as good R^2 .

Nash Sutcliffe Efficiency (E)

The efficiency E or η was proposed by Nash and Sutcliffe in the year 1970. It is defined as one minus the sum of the absolute squared differences between the calculated and observed values normalized by the variance of the observed values during the period of study given by equation 3.

$$E = 1 - \frac{\sum_1^n (Q_{obs_i} - Q_{sim_i})^2}{\sum_1^n (Q_{obs_i} - \overline{Q_{obs}})^2} \dots (3)$$

Where, Q_{obs_i} is the observed discharge,

Q_{sim_i} is the simulated discharge,

$\overline{Q_{obs}}$ is the Average observed discharge.

Performance rating of NSE

The Nash Sutcliffe efficiency ranges from $-\infty$ to 1. Efficiency of '1' refers to perfect match of the modeled discharge to observed discharge.

Efficiency of '0' means that the modeled simulation are as accurate as the mean of the observed discharges. Efficiency less than zero mean that the prediction or simulations are not accurate and the observed mean is more accurate. The performance rating table (Moriassi *et al.*, 2007) is shown in Table 3.6.

Coefficient of correlation (R)

The coefficient of correlation (r) measures the strength and the instruction of a linear relationship between observed and simulated discharges.

The coefficient of correlation (r) is sometimes also known as Pearson product moment correlation coefficient, as giving honor to its developer Karl Pearson. It is given by equation 4

$$r = \frac{n \sum Q_{obs_i} Q_{sim_i} - (\sum Q_{obs_i})(\sum Q_{sim_i})}{\sqrt{n(\sum Q_{obs_i}^2) - (\sum Q_{obs_i})^2} \cdot \sqrt{n(\sum Q_{sim_i}^2) - (\sum Q_{sim_i})^2}} \dots (4)$$

Where, Q_{obs_i} is the observed discharge,

Q_{sim_i} is the simulated discharge

Root Mean Square Error (RMSE)

Root Mean Square Error (RMSE) was used by Fleming (1975) was another technique applied to assess the reliability of model. This technique can be taken to be a measure of absolute error between the observed and simulated discharges. It is defined by equation 5.

$$RMSE = \sqrt{\frac{1}{n} \sum_{i=1}^n (Q_{obs_i} - Q_{sim_i})^2} \dots (5)$$

Where, Q_{obs_i} is the observed discharge,

Q_{sim_i} is the simulated discharge

RRL AWBM model requires the basic information about the study that is the name of the study area and the area of the location. In our study the name of the location is Shipra river basin and the area is 2102 km².

The input data required in the model is daily rainfall, daily runoff and daily evapotranspiration data in.tts format which was prepared before the data was inserted in the model. The input for the given time series are represented graphically before the model is run.

The model was run for calibration and validation purpose for determining the Nash Sutcliffe Efficiency and for this the time series for calibration and validation is decided. In the current study the time series for calibration is 01/01/1990 to 31/12/2000

and the time series for validation is 01/01/2001 to 31/12/2010 which was inserted in the model for performing the function.

Results and Discussion

Results of AWBM RRL rainfall runoff model for calibration period is shown in table 4.1. The graphical representation of relation among observed and calculated runoff for the training period is depicted in the figure 1.

Figure 2 demonstrate the comparison among observed discharge and computer-generated discharge during the calibration of model. From the analysis, it was seen that the observed and simulated discharge were matching well.

The validation for the model is done for the period of 01/01/2001 to 31/12/2010 and result for the same is shown in table 4.2.

Model testing is the calibre of the model to approximate runoff for periods off with that used to training the model. The model was run for its testing using training model parameters and data of arrears period from year 2001 to 2010 and statistics of the output were likened with the training results.

The coefficient of correlation for the testing process of the model was observed as 0.807, indicating satisfactory agreement between the spurious and observed catchment runoff in terms of the spire flows with respect to timing, rate and volume. Figure 3 shows the graphical representation of the results obtained during model validation. From the analysis of results of model validation, it can also be concluded that, the model parameters obtained during model calibration can be used for predicting the runoff time series to the extended time era in the shipra basin and it can be used for predicting runoff time series of another basin of similar characteristics using the rainfall data (Fig. 4).

Sensitivity analysis

The sensitivity analysis helps to finding the uncertainty of model parameter. Sensitivity analysis is helpful for a range this includes evaluating the robustness of the results of a model or system.

The understanding of the relationships between input and output variables in a model is enhanced. The input parameters can be fixed which do not have any effect of the model and the rest parameters can be focussed.

Sensitivity analysis of A1

Sensitivity graph of A1 is shown in Figure 5. It was observed that the change in the value of A1 has not found much impact on the Efficiency Index (E). So A1 was observed as Non sensitive parameter in AWBM Model.

Sensitivity analysis of A2

Sensitivity graph of A2 is shown in Figure 6. It was observed that the change in the value of A2 has not found much impact on the Efficiency Index (E). So A2 was observed as Non sensitive parameter in AWBM Model.

Sensitivity analysis of BFI

Sensitivity graph of BFI is shown in Figure 7. It was observed that the change in the value of BFI has found much impact on the Efficiency Index (E). So BFI was observed as Sensitive parameter in AWBM Model.

Sensitivity analysis of C1

Sensitivity graph of C1 is shown in Figure 8. It was observed that the change in the value of C1 has not found much impact on the Efficiency Index (E). So C1 was observed as Non Sensitive parameter in AWBM Model.

Table.1 Performance rating on NSE basis

Performance Rating	NSE
Very good	$0.75 \leq \text{NSE} \leq 1.00$
Good	$0.65 \leq \text{NSE} \leq 0.75$
Satisfactory	$0.50 \leq \text{NSE} \leq 0.65$
Un-satisfactory	$\text{NSE} \leq 0.50$

Table.2 Result for the calibration period

PARAMETERS	AWBM RRL model
Coefficient of determination (R^2)	0.842
Coefficient of correlation (r)	0.910
Nash Sutcliff Efficiency (%)	82.3
Root Mean Square Error	41.40

Table.3 Results of AWBM RRL rainfall runoff model for validation period

PARAMETERS	AWBM RRL model
Coefficient of determination (R^2)	0.658
Coefficient of correlation (r)	0.807
Nash Sutcliff Efficiency (%)	62.57
Root Mean Square Error	39.74

Fig.1

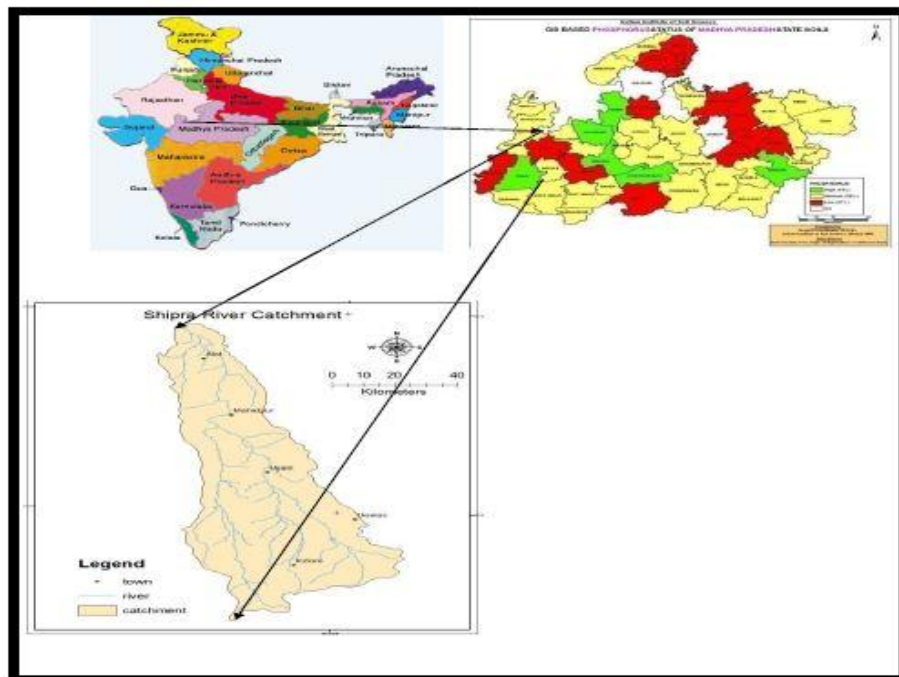

Fig.2 Shipra river catchment and drainage network

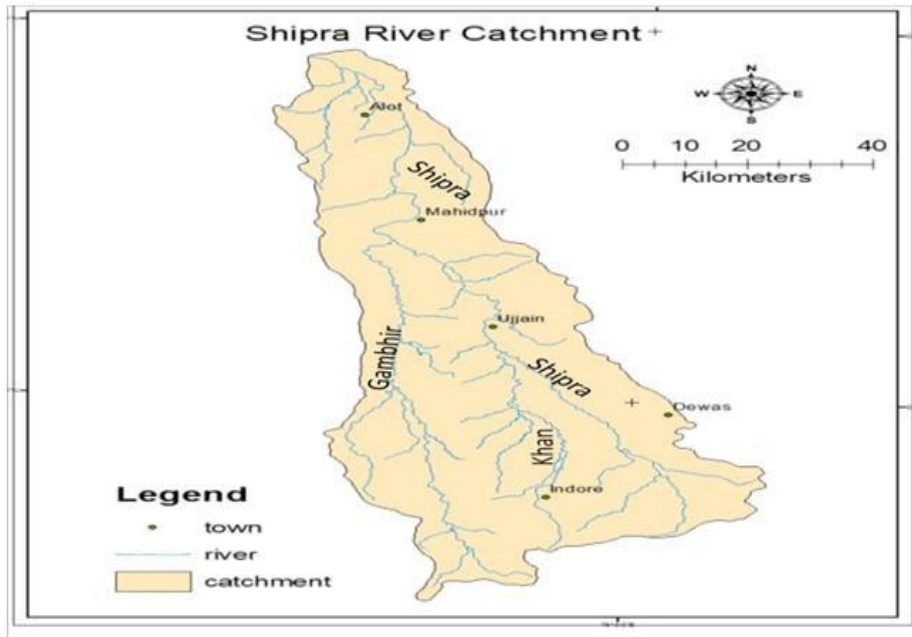

Fig.3 Structure of RRL AWBM Model

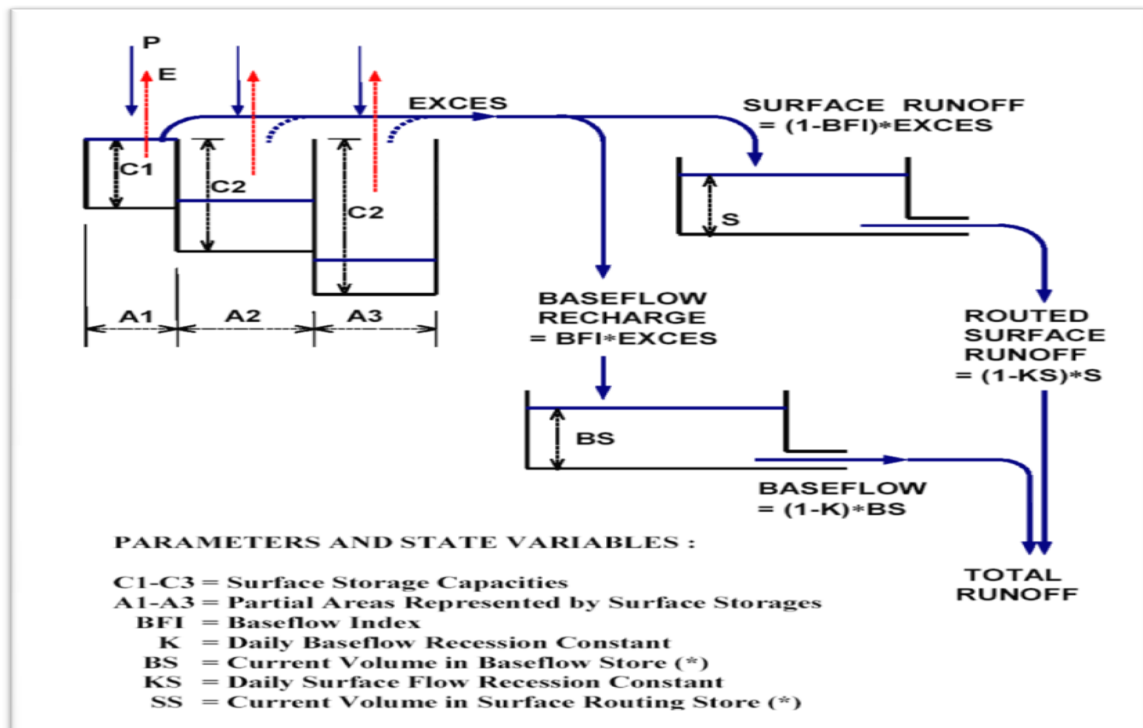

Fig.4 Propinquity among observed and calculated runoff for the training period from 01/01/1990 to 31/12/2000

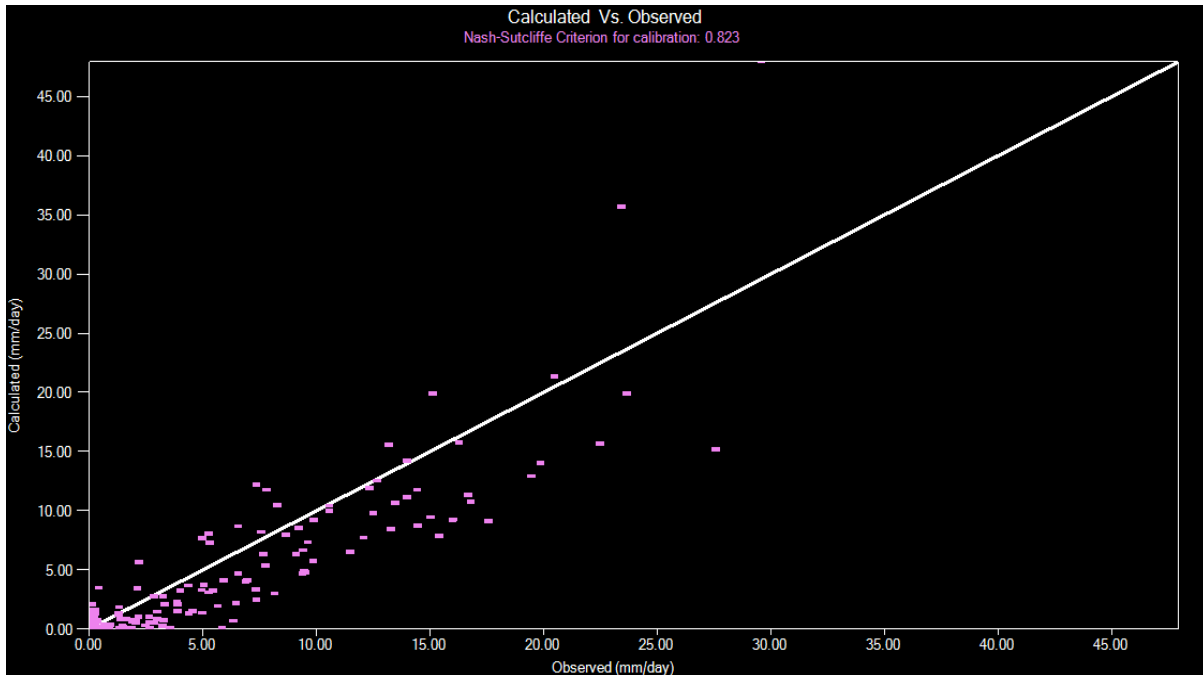

Fig.5 Propinquity among observed and computer-generated discharge for training

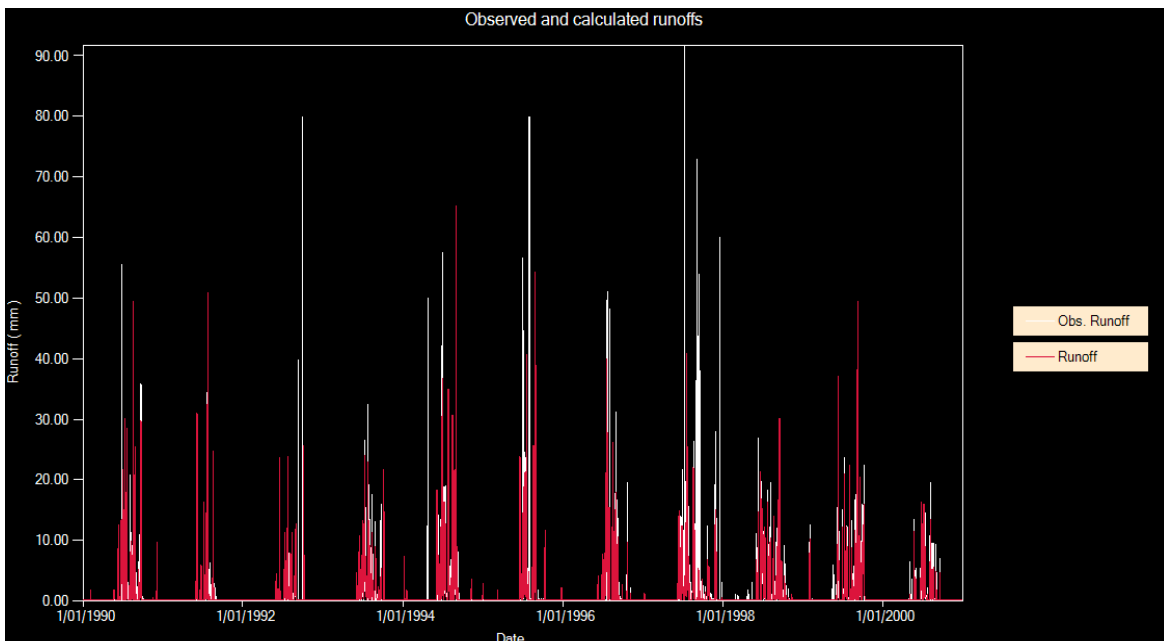

Fig.6 Proximity among observed and simulated discharge for testing period

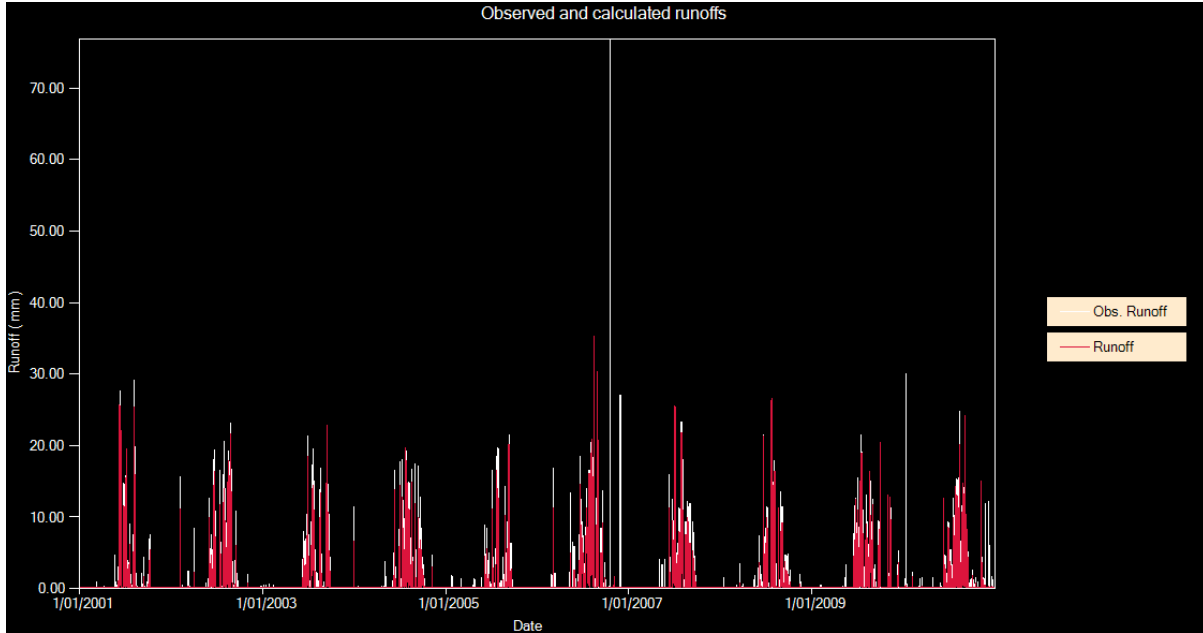

Fig.7 Sensitivity graph for A1 (x axis is parameter A1 and y axis is Efficiency Index)

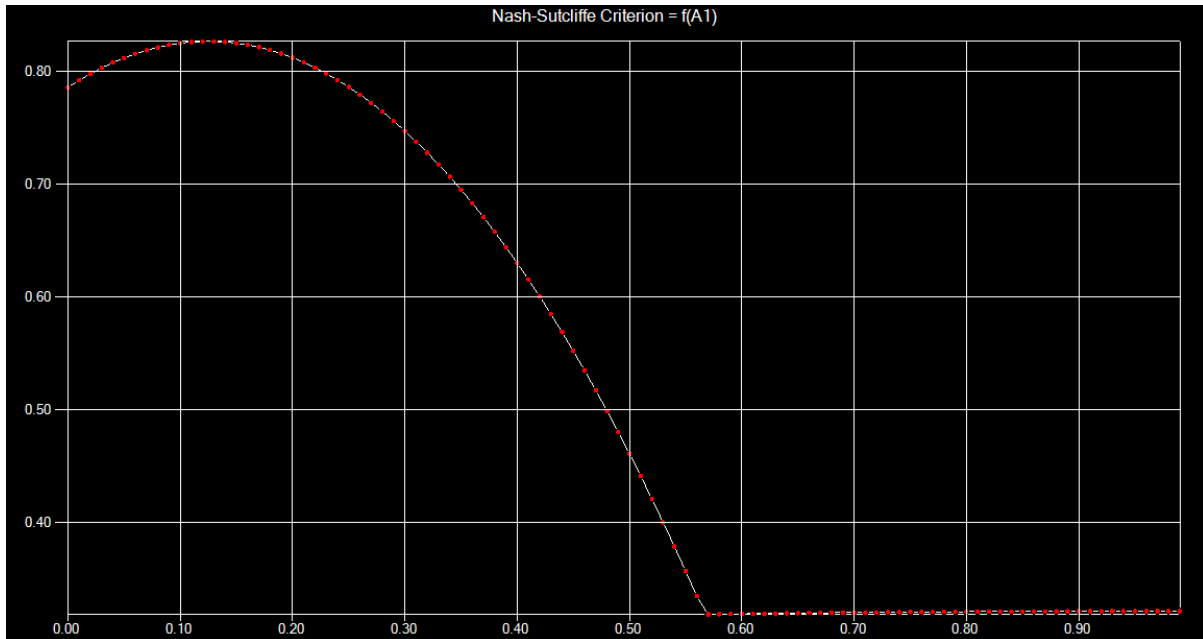

Fig.8 Sensitivity graph for A2 (x axis is parameter A2 and y axis is Efficiency Index)

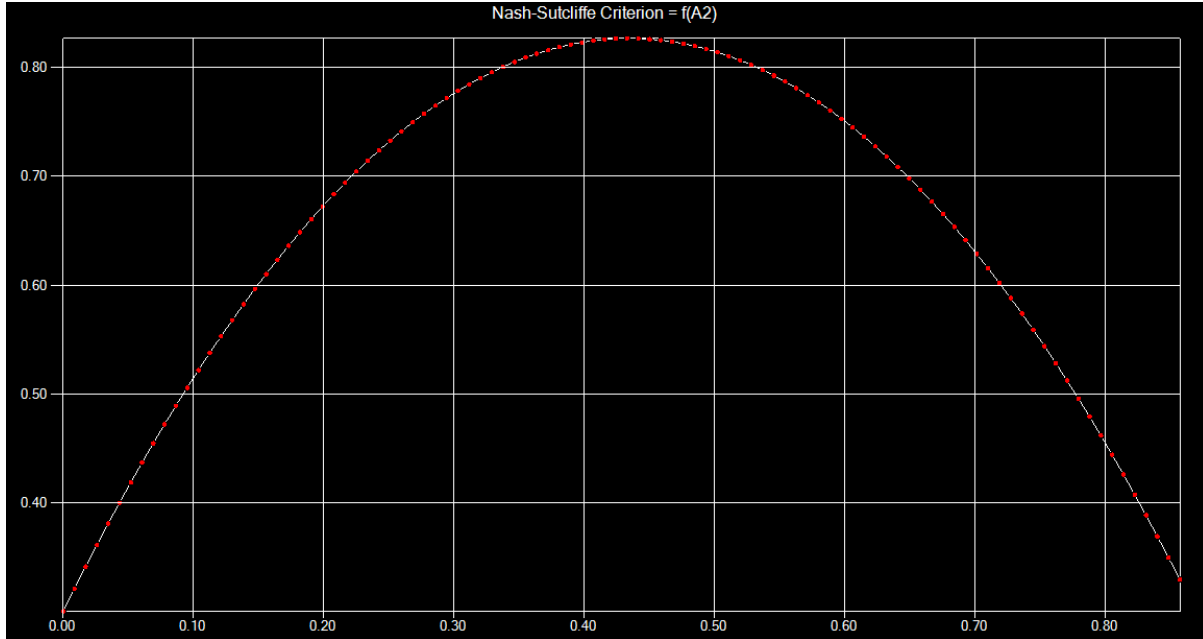

Fig.9 Sensitivity graph for BF1 (x axis is parameter BF1 and y axis is Efficiency Index)

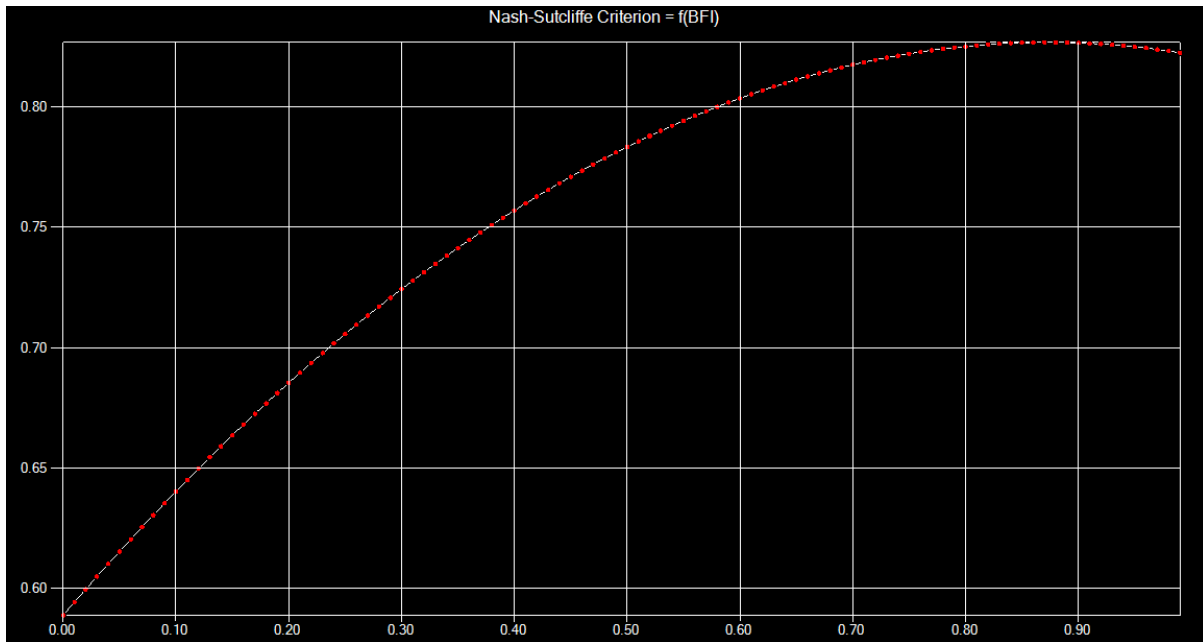

Fig.10 Sensitivity graph for C1 (x axis is parameter C1 and y axis is Efficiency Index)

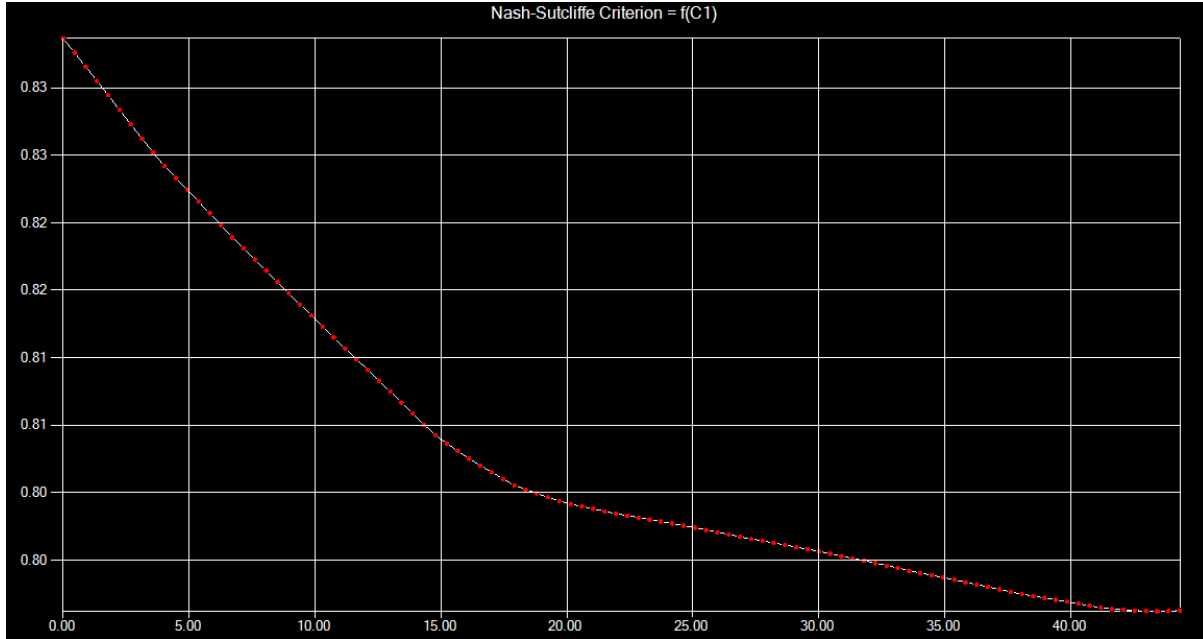

Fig.11 Sensitivity graph for C2 (x axis is parameter C2 and y axis is Efficiency Index)

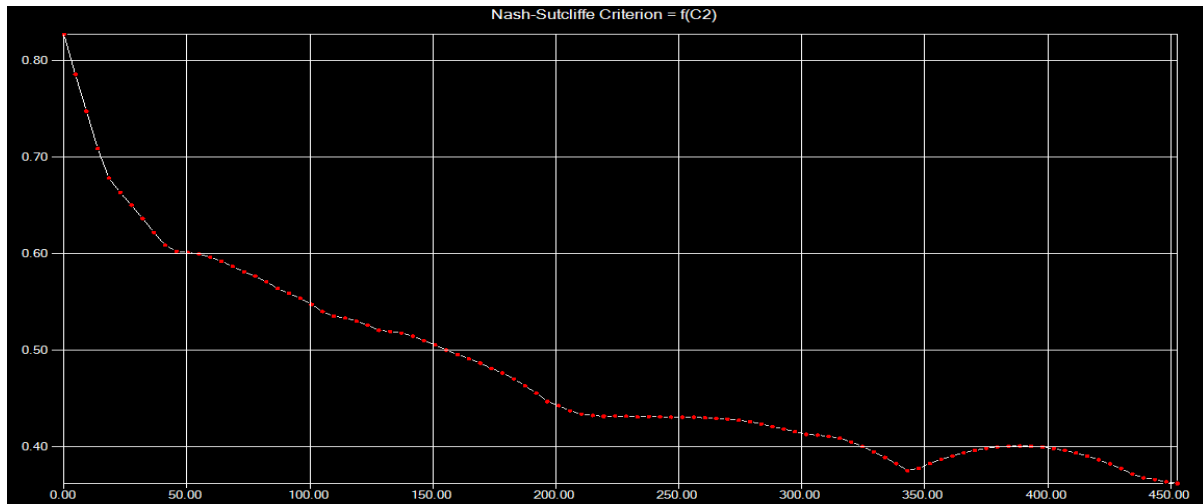

Fig.12 Sensitivity graph for C3 (x axis is parameter C3 and y axis is Efficiency Index)

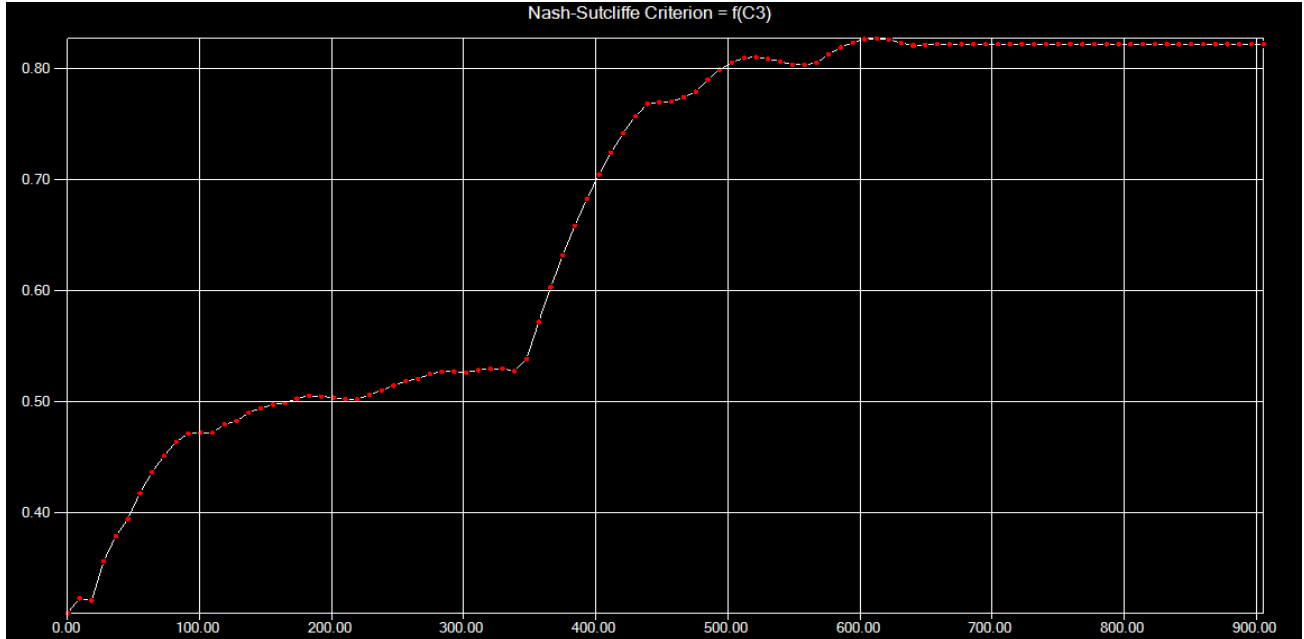

Fig.13 Sensitivity graph for KBase (x axis is parameter KBase and y axis is Efficiency Index)

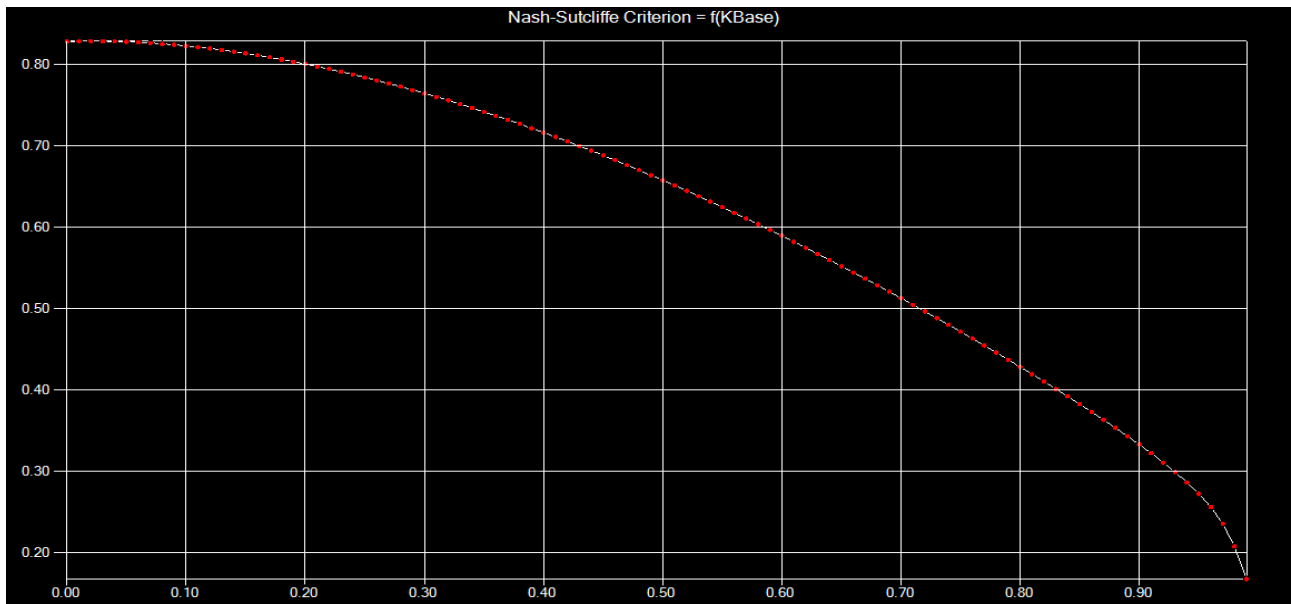
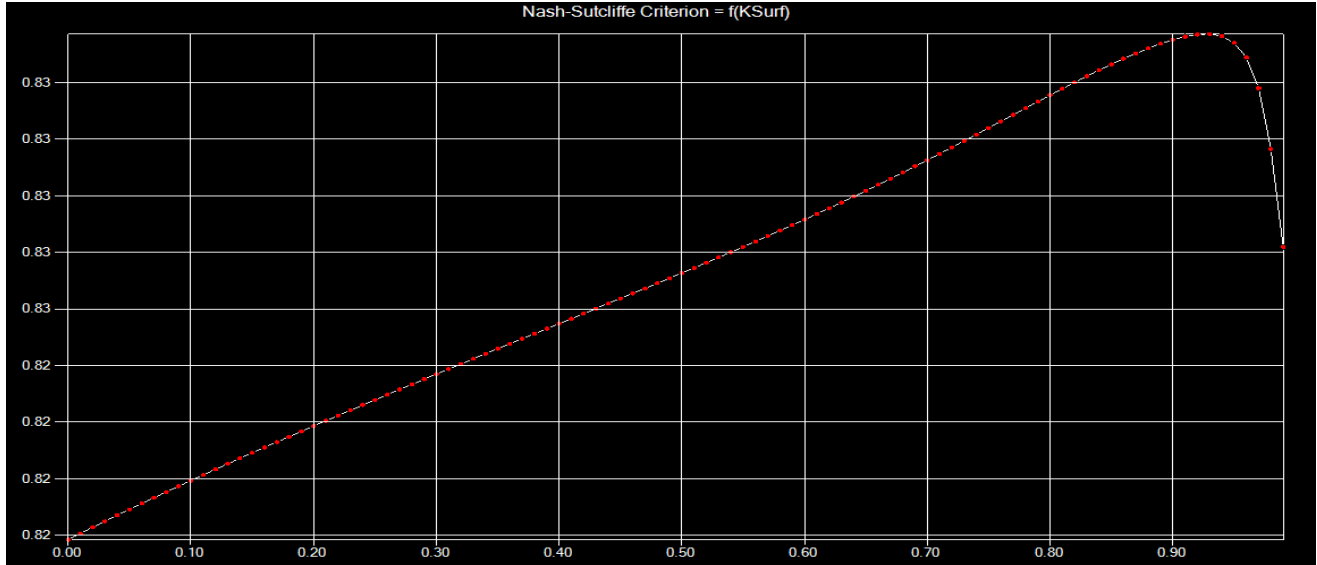

Fig.14 Sensitivity graph for Ksurf (x axis is parameter Ksurf and y axis is Efficiency Index)



Sensitivity analysis of C2

Sensitivity graph of C2 is shown in Figure 9. It was observed that the change in the value of C2 has not found much impact on the Efficiency Index (E). So C2 was observed as Non Sensitive parameter in AWBM Model.

Sensitivity analysis of C3

Sensitivity graph of C3 is shown in Figure 10. It was observed that the change in the value of C3 has found less impact on the Efficiency Index (E). So C3 was observed as Moderately Sensitive parameter in AWBM Model.

Sensitivity analysis of Kbase

Sensitivity graph of Kbase is shown in Figure 11. It was observed that the change in the value of Kbase has found much impact on the Efficiency Index (E). So Kbase was observed as Sensitive parameter in AWBM Model.

Sensitivity analysis of Ksurf

Sensitivity graph of Ksurf is shown in Figure

12. It was observed that the change in the value of Ksurf has found much impact on the Efficiency Index (E). So Ksurf was observed as Sensitive parameter in AWBM Model.

The RRL AWBM model was developed for the Shipra river basin for the time series of 1990 to 2010 and the calibration was performed for the year 1990 to 2000 and then the validation was performed for the year 2001 to 2010. The suitability of RRL AWBM Model based on the criteria of coefficient of determination (R^2), coefficient of correlation (r), Nash Sutcliffe efficiency (%) and root mean square error. The results of AWBM RRL model for training and testing period that is from 1990 to 2000 and from 2001 to 2010 shows that coefficient of determination (R^2) is 0.842 and 0.658, coefficient of correlation (r) is 0.910 and 0.807, Nash Sutcliffe efficiency (%) is 82.3 % and 62.57 % and root mean square error is 41.40 and 39.74 respectively.

The RRL AWBM model was found helpful in predicting runoff with high degree of accuracy in Shipra basin. The RRL AWBM model performs well to simulate runoff in

good agreement. The RRL AWBM model thus developed in Shipra basin seems to be capable of predicting runoff for extended time period to reproduce the hydrological return of the basin to the rainfall. The model could also be used to simulate the runoff in other sub basin of similar characteristics. RRL AWBM Model is available in free domain and can be easily downloaded from its official website. The model could also be used to simulate the runoff in other sub basin of similar characteristics.

References

- Baldocchi. 2001. Assessing ecosystem carbon balance: problems and prospects of the eddy covariance technique. *Annual Review of Ecology and Systematics* 33: 15-18.
- Balvanshi A and Tiwari HL. 2015. Rainfall runoff estimation using RRL toolkit. *International Journal of Engineering Research & Technology* Vol 4 (5): 595-599.
- Bhola PK. 2010. Rainfall-runoff modeling of river kosi using SCS-CN method and ANN. Bachelor of Technology. Thesis, National Institute of Technology Rourkela.
- Boughton W. 2004. Estimating the sensitivity of mean annual runoff to climate change using selected hydrological models. *Advances in Water Resources*: 1-32.
- Boughton W. 2004. The Australian Water Balance Model Environmental Modeling and Software. Elsevier 19(10): 943-956.
- Boughton. 2007. Effect of data length on rainfall-runoff modelling. *Environmental Modelling and Software* 22(3): 406-413.
- Boughton. 2009. Selecting parameter values for the AWBM daily rainfall-runoff model for use on ungauged catchments 4: 1-19.
- Bronstert A. 2002. Effects of climate and land-use change on storm runoff generation. *Hydrological Processes* 16(2): 509-529.
- Chiew FHS, Teng J, Vaze J, Post DA, Perraud JM, Kirono DGC and Viney NR. 2009. Estimating climate change impact on runoff across southeast Australia: method, results, and implications of the modeling method. *Water resources research* 45: 15-18.
- Choudhari K, Panigrahi B and Paul JC. 2014. Simulation of rainfall-runoff process using HEC-HMS model for Balijore. *Hydrological Processes*. 8(2) 19-24.
- Chouhan D, Tiwari HL and Galkate RV. 2016. Rainfall runoff simulation of Shipra river basin using AWBM RRL toolkit. *International Journal of Engineering and Technical Research* 5 (3): 73-76.
- Chowdhury S and Sharma A. 2008. A simulation based approach for representation of rainfall uncertainty in conceptual rainfall runoff models. *Hydrological Research Letters* 2: 5-8.
- Cobon D. 2007. Practical adaptation to climate change in regional natural resource management. Department of Natural Resources and Water, Queensland Climate Change Centre of Excellence, Toowoomba.
- Gilanipour J and Gholizadeh B. 2016. Prediction of rice water requirement using fao-cropwat model in north iran under future climate change. *International Conference Environmental Sciences* 2: 18-22.
- Gilbert and RO. 1987. Statistical methods for environmental pollution monitoring. Van Nostrand Reinhold, New York.
- Gleick P, Shiklomanov IA. 1989. The impact of climate change for water resources. Second meeting of IPCC WG-2, WMO/UNEP, Geneva.

- Gobena S. 2010. daily rainfall runoff modelling of upper awash sub basin using conceptual rainfall runoff models. Ph.D. Thesis, ADDIS ABABA UNIVERSITY.
- Haifang Y, Changsing S, Wenwei S, Bai J and Yang H. 2015. Impacts of climate change and human activities on runoff and sediment load of the Xiliugou basin in the Upper Yellow river. *Advances in Meteorology* 48(17): 12.
- Haque PMP, Rahman M, Hagare A, Kibria D, Golam. 2014. Parameter uncertainty of the AWBM model when applied to an ungauged catchment. *Hydrological Processes* 29(6): 15-19.
- Hashem A, Engel B, Bralts V, Radwan S and Rashad M. 2016. Performance evaluation and development of daily reference evapotranspiration model. *Irrigation & Drainage Systems Engineering* (5): 157.
- Jamal JF and Jain A. 2011. Comparison of conceptual and neural network models for daily rainfall-runoff modelling. *International Conference on Chemical, Ecology and Environmental Sciences* 6(4): 13-19.
- Jones RN and Durack PJ. 2005. Estimating the impacts of climate change on victoria's runoff using a hydrological sensitivity model. CSIRO Atmospheric Research, Melbourne.
- Jones RN, Chiew FHS, Boughton WC and Zhang L. 2005. Estimating the sensitivity of mean annual runoff to climate change using selected hydrological models. *Advances in Water Resources* 23: 27-29.
- Jones RN, Chiew FHS, Boughton WC and Zhang L. 2006. Estimating the sensitivity of mean annual runoff to climate change using selected hydrological models. *Advances in Water Resources* 29(10): 1419-1429.
- Kumar PS, Praveen TV and Prasad MA. 2016. Artificial Neural Network model for rainfall-runoff -a case study. *International Journal of Hybrid Information Technology* 9 (3): 263-272.
- Kumar R, Chatterjee G, Singh C and Kumar S. 2013. Runoff estimation for an ungauged catchment using geomorphological instantaneous unit hydrograph (giuh) models. *Hydrological Processes* 21(14): 1829-1840.
- Trivedi, A. *et al.*, (2019). Impact of Climate Change Using Trend Analysis of Rainfall, RRL AWBM Toolkit, Synthetic and Arbitrary Scenarios. *Current Journal of Applied Science and Technology*. 1-18
- Kumar R. 2011. *Research Methodology: A Step-by-Step Guide for Beginners*.(3). Sage, New Delhi.
- Linde AH, Aerts JC, Hurkmans RT, and Eberle M. 2008. Comparing model performance of two rainfall-runoff models in the Rhine basin using different atmospheric forcing data sets. *Hydrology Earth System Science* 12: 943-957.
- Lingling Z, Jun XIA, Chong YU, Zhonggen W, Leszek S and Cangrui L. 2013. Evapotranspiration estimation methods in hydrological models. *Journal of Geogr. Sci* 23(2): 359-369.
- Linz H, Shiklomanov I, Mostefakara K. 1990. Chapter 4 Hydrology and water Likely impact of climate change IPCC WGII report WMO/UNEP Geneva.
- Mulligan M. 2004. *Environmental Modelling Finding Simplicity in Complexity*. Department of Geography, King's College London.
- Najar HAL. 2011. The integration of FAO-CropWat Model and GIS Techniques for estimating irrigation water requirement and its application in the

- Gaza strip. *Natural Resources* 2 (3): 146-154.
- Nayak PC, Venkatesh B, Krishna B and Jain SK. 2013. Rainfall – runoff modelling using conceptual, data based and wavelet based computing approach. *Journal of Hydrology* 493: 57-67.
- Nkomozepe H, Chung T, Sang K. 2014. Uncertainty of hydro-meteorological predictions due to climate change in the republic of Korea. *Journal of Korea Water Resources Association*. 47: 22-28.
- Trivedi, A. *et al.*, (2018). Estimation of Evapotranspiration using CROPWAT 8.0 Model for Shipra River Basin in Madhya Pradesh, India. *Int. J. Curr. Microbiol. Appl. Sci.* 7, 11. <https://doi.org/10.20546/ijcmas.2018.705.151>